

## LS-45-24 DALI2 LI



■ Approve



### ■ Features

- Class II, SELV, independent
- Input Voltage 220-240VAC
- Protections: SCP/OLP/OVP
- Power Factor >0.95
- Efficiency ≥86%
- Support DALI II, Push Dimming
- 5 years warranty

### ■ Applications

- LED strips
- Linear light
- Troffer light

### ■ Description

LS-45-24 DALI2 LI is a 45W constant Voltage LED driver that operates from 176-264Vac input with 24V output voltage. With its compact dimensions from 187 x 45 x 30.5 mm it is easy to integrate in linear light and troffer light products. To ensure trouble-free operation, protection is provided against output short circuit and over Load.

### ■ Model code

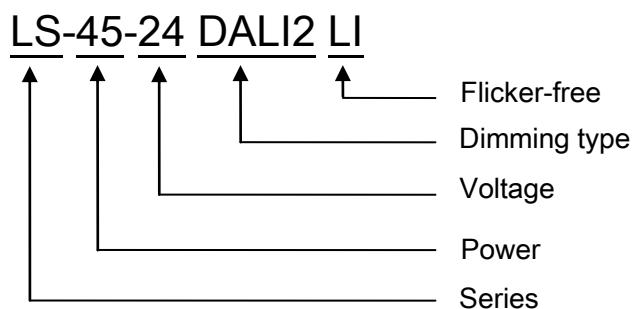

# 45W Constant Voltage DALI2-LS Series

LS-45-24 DALI2 LI

## ■ Specification

Input	Rated input voltage	220-240VAC
	Range of input voltage	176-264VAC
	DC voltage range	176-280V
	Frequency(Hz)	0/50/60 Hz
	Power Factor	> 0.95@Full Load,230VAC
	Input Current max	0.35A MAX. @Full Load,176VAC
	Start-up time	< 1S
	Unload Power Consumption	≤0.5W
	Inrush Current	40A Max.
	THD	≤20% @Full Load,240VAC
	Leakage Current	< 0.5mA(240VAC)
Output	Constant Voltage	24VDC
	Current Range	0-1.88.A
	Rated power	45W Max.
	Voltage Accuracy	±5%@220-240VAC
	Voltage Regulation	±1% @Full Load
	Load Regulation	≤2%
	Hold-up Time	1s max.@Full Load
	Ripple& Noise *Note.2	≤0.24Vp-p@Full Load,240VAC
	Output LF current ripple(<120Hz)	≤±1% @Full Load,240VAC
	PWM Frequency	4kHz
	Efficiency(Typ.)	≥86%
Dimming	Dimmable	YES
	Dimming mode	DALI II, Push
	Dimming current range	1%~100%
Protection	Over Load Protection	105-150%
		Protection type: Auto Resume
	Over Voltage Protection	> 25.2VDC
		Protection type: Auto Resume
Short circuit Protection	Protection type : Latch off , Auto recovery after power off and restart	
Over Temperature protection	Protection type: Auto Resume	
Environment	Operating Temperature	-20°C...+50°C
	tc	85°C
	Storage Temperature	-30°C...+65°C
	Temperature coefficient	±0.03%/°C(0-50°C)
	Life time	> 44,000h@ta=50°C
Humidity	20%-90%RH	
Others	Dimension	187X45X30.5(LXWXH)mm
Safety & EMC	Safety standards	EN 61347-1; EN61347-2-13; EN62384;
	Withstand voltage	Input-Output : 3750V/5mA/1min
	Isolation resistance	Input-Output : ≥4MΩ@500VDC
	EMI	EN55015; EN61000-3-2 Class C; EN61000-3-3
	EMS	EN 61547; EN 61000-4-2; EN 61000-4-5 —1000V;
Note	<p>1.All parameters NOT specially mentioned are measured at 240VAC input , full load and 25°C of ambient temperature.</p> <p>2.Ripple &amp; Noise are measured at 20MHz of bandwidth by using a 300mm twisted pair-wire terminated with a 0.1uF &amp; 47 uF parallel capacitor.</p>	

■ Model list

No.	Model number	Input			Output		
		Voltage (VAC)	Current (A)	Frequency (Hz)	Constant voltage (VDC)	Normal working current (A)	P <sub>rated</sub> (W)
1	LS-45-24 DALI2 LI	220-240	0.35	50/60	24	0-1.88	45

■ Wiring diagram

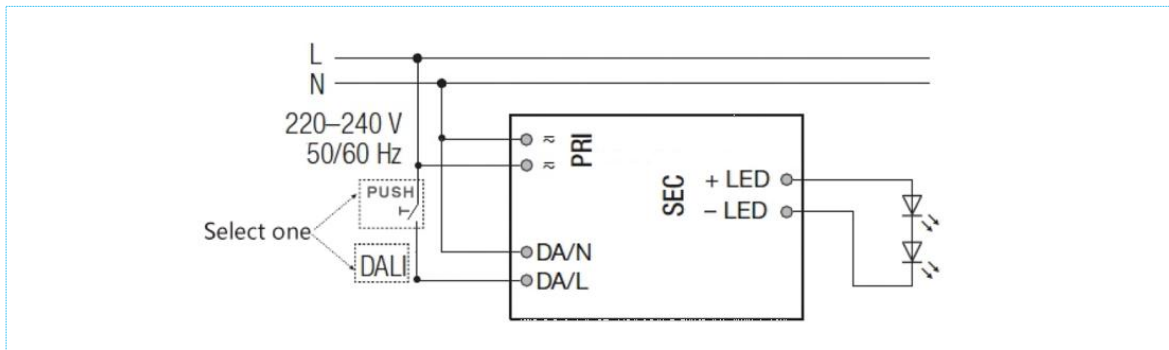

■ 2D diagram

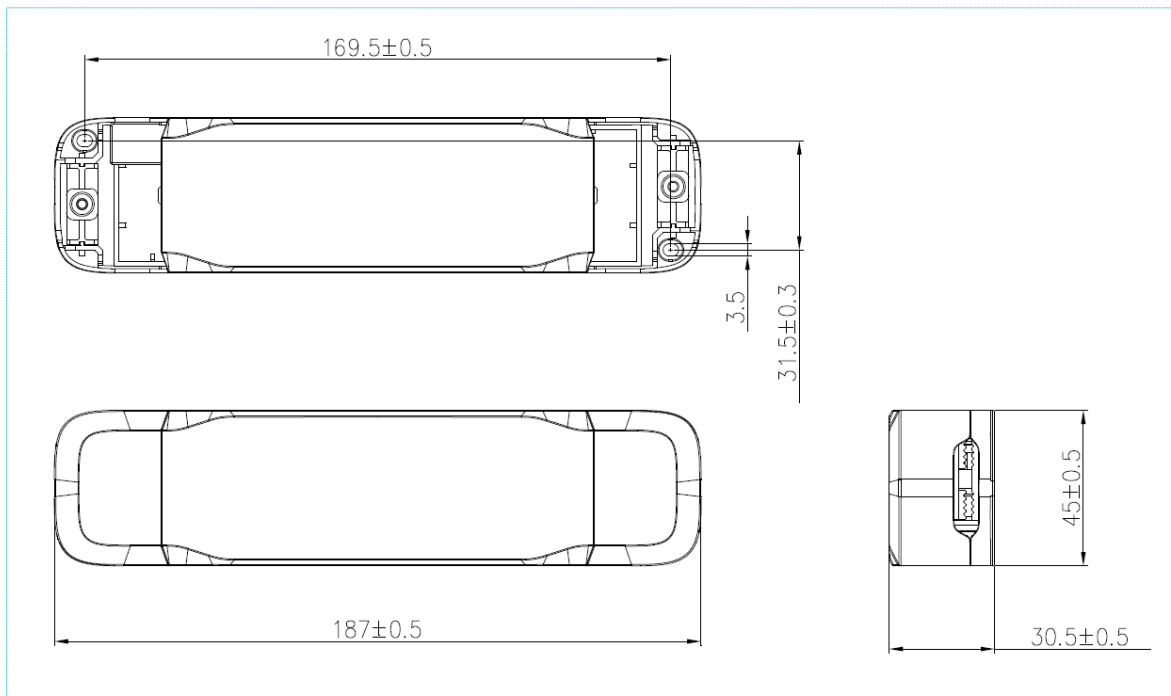

■ Curve

Lifetime vs. Ambient Temperature Curve

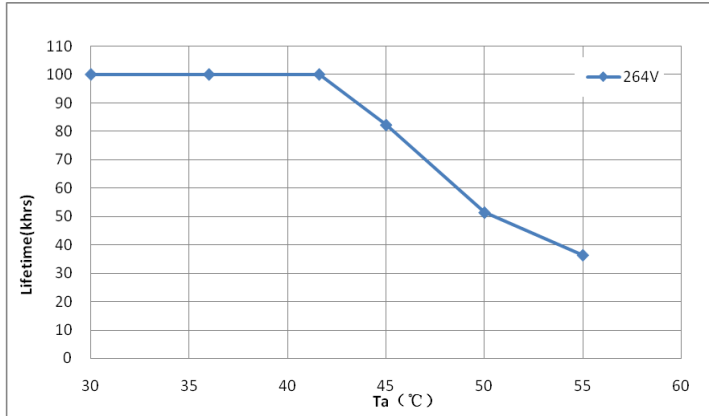

Efficiency vs. Load

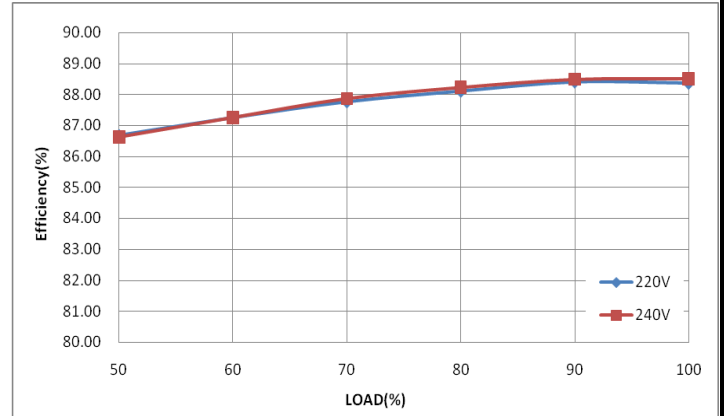

Power Factor Characteristics

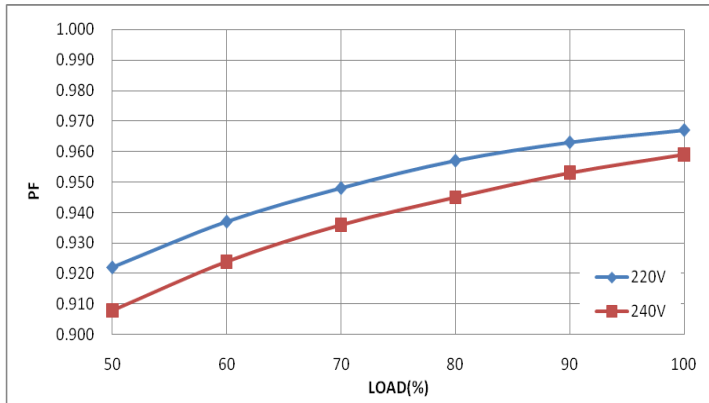

THD vs. Load

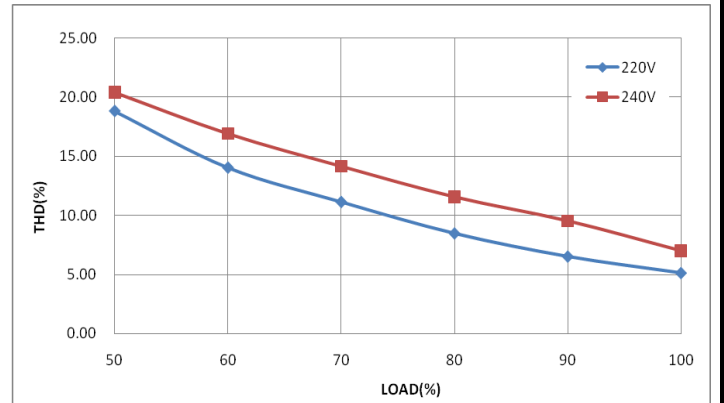

■ Operating window

